

# Modeling the Impacts of Restrictive Formularies on Patients With HIV

James Baumgardner, PhD; Caroline Huber, MPH; Mina Kabiri, PhD; Lara Yoon, MPH; Jacki Chou, MPP, MPL; and John Romley, PhD

The past 20 years have seen a rapid development of innovative antiretroviral therapies allowing patients with HIV to live longer and healthier lives and reducing the risk of transmission.<sup>1</sup> Molecules approved since the early 2000s are more effective and associated with fewer and less serious adverse events (AEs) than earlier HIV therapies.<sup>2</sup> The combination of these therapies into single-tablet regimens (STRs) has also simplified treatment administration, enhancing adherence and viral suppression.<sup>3-6</sup> Despite the availability of these improved treatment options, fewer than half of the 1.1 million Americans living with HIV in 2015 were engaged in care and achieved viral suppression.<sup>7,8</sup>

Many factors impact engagement in care and viral suppression. Formulary and utilization management policies, such as tiering and step therapy, that require patients to initiate therapy on cheaper regimens before moving to potentially more effective alternatives can reduce access to drugs that receive less desirable formulary placement.<sup>9-11</sup> For patients with HIV, formulary restrictions may have a number of repercussions, such as reduced adherence and viral suppression.<sup>12-14</sup> Further, requiring patients to initiate one regimen before accessing others, without consideration of patient heterogeneity, may adversely impact those with comorbid conditions.<sup>1</sup> Healthcare costs and utilization may also increase because of reduced viral suppression or increased AEs.

New therapies, such as those based on tenofovir alafenamide (TAF), continue to reduce the likelihood and severity of AEs, decreasing the possibility of a patient switching or discontinuing treatment.<sup>15-23</sup> Although common AEs like nausea and headaches still occur across all HIV regimens, more serious events like renal failure or bone fractures are mitigated with the newest options.<sup>18,19,23</sup> Still, despite demonstrated improvements in reducing AEs, new regimens are not always immediately available for patients because of formulary and utilization management policies.

## Study Objectives

We aimed to model the impacts of restrictive formulary designs on outcomes for patients with HIV and to demonstrate the costs

## ABSTRACT

**OBJECTIVES:** To model the impacts of restrictive formulary designs on outcomes for patients with HIV and to demonstrate the costs of restricting access to novel HIV regimens with better safety and efficacy profiles.

**STUDY DESIGN:** We modified an epidemiological model of HIV incidence, progression, and treatment to simulate the effects of 5 formulary scenarios on patient outcomes in the United States.

**METHODS:** Using a cohort of HIV-susceptible individuals, we followed patients through HIV infection, disease progression, and death. Patients transitioned in and out of treatment states once infected. Treatment discontinuation, efficacy, and the rate of adverse events (AEs; renal failure and bone fracture) in each formulary scenario depended on the treatment path and regimens included. Outcomes of interest included all-cause cumulative deaths, annual rates of AEs, and costs associated with treating those AEs.

**RESULTS:** All outcomes of interest were more favorable in less restrictive formulary scenarios that provided fewer barriers to appropriate treatments. By 2025, more restrictive formularies would have resulted in 171,500 more cumulative bone and renal events among treated patients with HIV compared with an open formulary. This corresponds to AE treatment costs of \$3.65 billion in more restrictive formularies compared with \$1.43 billion in an open formulary. Finally, compared with an open formulary, there would be an additional 16,200 cumulative deaths in more restrictive formularies.

**CONCLUSIONS:** Less restrictive formulary designs, which allow patients with HIV to initiate potentially safer and more efficacious regimens based on their proclivity to AEs, yield better outcomes and reduce costs.

*Am J Manag Care.* 2018;24(Spec Issue No. 8):SP322-SP328

of restricting access to novel HIV regimens that have better efficacy and safety profiles.

## TAKEAWAY POINTS

This study evaluated the impact of formulary designs on HIV patient outcomes, specifically the frequency and costs of certain adverse events and excess mortality. Findings are relevant for policy makers developing formulary management approaches for HIV treatments.

- ▶ Compared with an open formulary, more restrictive formularies would have 171,500 more cumulative bone and renal events among treated patients by 2025.
- ▶ Cumulative costs from these events in the more restrictive formularies would total \$3.65 billion by 2025 compared with \$1.43 billion in an open formulary.
- ▶ In more restrictive formulary scenarios, there would be 16,200 more cumulative deaths by 2025 compared with an open formulary.

## METHODS

### Model Overview

We modified a previously developed epidemiological model of HIV incidence, progression, and treatment to simulate the effects of 5 HIV formulary scenarios on patient outcomes in the United States (**eAppendix A** [eAppendices available at [ajmc.com](http://ajmc.com)]).<sup>24,25</sup> Our model incorporated incoming cohorts of HIV-susceptible individuals, natural progression of HIV for treated and untreated individuals, and death. Individuals transitioned to different disease stages at rates based on the HIV-infected population size and infectivity in treated and untreated populations. The HIV natural history progression was defined according to the CDC's clinical classifications of HIV disease stages<sup>26</sup>: Patients in stage 1 had CD4+ cell counts greater than 500 cells/mL; stage 2, 350 to 499 cells/mL; stage 3, 200 to 349 cells/mL; and stage 4, fewer than 200 cells/mL. We used data from the CDC to estimate the distribution of recently infected individuals by stage.<sup>26</sup> We also included transitions between treated and untreated states according to treatment initiation and discontinuation rates and the possibility of switching HIV regimens (described later).<sup>24,25</sup>

Our model started with 1.2 million people infected with HIV in 2016.<sup>26</sup> We used published estimates from the CDC's Medical Monitoring Report and HIV Surveillance reports to obtain the distribution of the initial population by disease stage and treatment status (**eAppendix Table 2**).<sup>26,27</sup> We modeled HIV incidence through 2 categories of HIV transmission: (1) between untreated HIV-infected patients and susceptible individuals and (2) between treated HIV-infected patients and susceptible individuals. A lower rate of transmission was used for the latter category, reflecting the lower transmission rates observed for treated versus untreated infected patients.<sup>28,29</sup> **eAppendix A** presents the details of the model and parameters.

### Treatment Regimens and Formulary Scenarios

Our model included 4 STRs: emtricitabine/rilpivirine/tenofovir disoproxil fumarate (FTC/RPV/TDF), elvitegravir/cobicistat/emtricitabine/tenofovir disoproxil fumarate (EVG/COBI/FTC/TDF), elvitegravir/cobicistat/emtricitabine/tenofovir alafenamide (EVG/COBI/FTC/TAF), and abacavir/dolutegravir/lamivudine (ABC/DTG/3TC). A fifth regimen, darunavir/ritonavir (protease inhibitor [PI]) plus 2 or more nucleoside reverse transcriptase inhibitors (PI/2NRTIs), was included as a second-line therapy in the event of virologic failure in certain formularies.

To encapsulate a range of formulary treatment policies, we developed 5 formulary scenarios that differed in access to HIV treatment

regimens (**eAppendix B**). Within each formulary, patients faced AEs (specifically, renal toxicity or bone fracture) associated with certain HIV medications. Patients who experienced AEs or virologic failure switched to a different treatment regimen, determined by the rules of the particular formulary. Different efficacy and AE rates were used depending on pre-existing clinical conditions for patients. Treatment discontinuation rates were defined as the number of patients randomized to treatment who discontinued because of death, pregnancy, or study withdrawal, but did not include patients who discontinued treatment due to an AE. All parameter estimates were derived from the published literature or clinical trials. Detailed schematics for each formulary scenario can be found in **eAppendix B**.

The first formulary scenario, "most restrictive," distributed patients equally across the TDF-based regimens and only allowed access to the initial treatment, regardless of AEs. In the event of a virologic failure, however, patients were transitioned to a PI/2NRTIs regimen.

Under the second and third formulary scenarios, "step (renal)" and "step (any AEs)," respectively, patients were distributed equally across the TDF-based regimens and were transitioned to an alternative regimen (either ABC/DTG/3TC or EVG/COBI/FTC/TAF) after the occurrence of an AE. The step (renal) scenario only allowed patients to transition to EVG/COBI/FTC/TAF if they experienced a renal AE. Patients with a bone fracture event were moved to ABC/DTG/3TC. In contrast, the step (any AEs) scenario allowed for transitions to EVG/COBI/FTC/TAF if a patient experienced either of the AEs. Under both step scenarios, patients with virologic failure on their first-line regimen were moved to a second-line treatment of PI/2NRTIs.

The fourth scenario, "presorted" formulary, allowed pre-existing clinical conditions to determine the initial treatment regimen. Under this scenario, patients with an existing bone disease, osteopenia, started on ABC/DTG/3TC or EVG/COBI/FTC/TAF; patients with a disposition to a renal event started on EVG/COBI/FTC/TAF; and all other patients started on a TDF-based regimen. Switching regimens occurred in the case of an AE or treatment failure, as in the step formularies.

The last scenario, "open" formulary, was the least restrictive and reflected current market trends among a population facing minimal or no co-pays. Patients with osteopenia (35.1%) were started on

**FIGURE 1.** Difference Between Other Formulary Scenarios and Open Formulary in the Number of Cumulative All-Cause Deaths, Renal Events, and Bone Fractures (2016-2025)

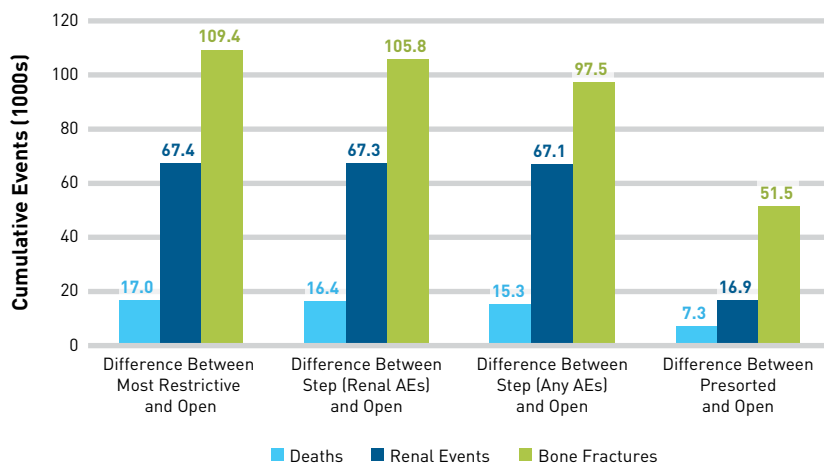

AE indicates adverse event.

ABC/DTG/3TC or EVG/COBI/FTC/TAF, whereas patients with a disposition to a renal AE (6.2%) were started on EVG/COBI/FTC/TAF. Additional patients were started on the TAF-based regimen such that this overall percentage matched the market distribution of treatment-naïve patients in the Ryan White program, a government program that provides cost-sharing assistance (and other services) to low-income people with HIV, as of the second quarter of 2016 (46%).<sup>30</sup> All other patients were started on a TDF-based regimen. Patients switched to an alternative regimen after treatment failure or AE.

An estimated 3% to 8% of individuals have allele HLA-B\*5701, which is associated with hypersensitivity reactions from the abacavir component in ABC/DTG/3TC.<sup>31-33</sup> Based on those estimates, we assumed that 5.5% of the population had the allele. In the relevant formularies, we respected the hypersensitivity of those patients by using EVG/COBI/FTC/TAF, where ABC/DTG/3TC would have otherwise been chosen.

### AE Costs

The costs of bone and renal AEs were calculated using data from the 2014 Medical Expenditure Panel Survey (eAppendix C).<sup>34</sup> Costs included inpatient, outpatient, emergency department, prescription, and office-based costs for each medical condition.

### Model Outcomes

Our model projected the annual number of renal AEs and bone fractures for the treated population, the cumulative value of treatment costs associated with these events over the next 10 years, and cumulative all-cause deaths. Costs are represented in 2016 US\$ and discounted at an annual rate of 3%.<sup>35</sup>

### Model Calibration

We calibrated the model by comparing the percentage of patients with HIV treated by 2020, cumulative deaths from 2016 to 2025, and number of prevalent HIV cases in 2025 with published estimates from Shah et al<sup>36</sup> by adjusting HIV infectivity and the rate of disease progression across treated and untreated stages.

## RESULTS

All outcomes of interest were most favorable for patients in the open formulary, followed by the presorted formulary. By 2025, the number of renal and bone AEs, costs associated with those events, and cumulative all-cause deaths were considerably lower in the open formulary than in the other scenarios (Figure 1).

### Calibration

Our calibrated parameters produced estimates of HIV cases by 2025 and the percentage of individuals on treatment in 2020 that aligned with those reported in Shah et al (eAppendix D).<sup>36</sup> Our model showed an increase in the HIV-infected population from 1.2 million in 2016 to approximately 1.53 million in 2025 under the 3 most restrictive formulary scenarios and 1.52 million in the open scenario. Those results fell within Shah et al's CI of 1.24 million to 1.57 million. Across the formulary scenarios, our model produced a range of 515,000 to 532,000 cumulative deaths from 2016 to 2025, all of which fall within Shah et al's CI of 364,000 to 578,000.

### Bone and Renal Events

The open scenario led to 171,500 and 68,500 fewer cumulative bone and renal events among treated patients with HIV by 2025 compared with the average of the 3 more restrictive scenarios and the presorted formulary scenario, respectively (Figure 1 and Figure 2). Although the number of AEs was the greatest under the most restrictive formulary scenario, both step therapy formulary scenarios resulted in more AEs than the presorted and open formularies.

### Costs

From 2016 to 2025, cumulative costs associated with both bone fractures and renal disease were \$2.23 billion higher in the step (renal) formulary, \$2.19 billion higher in the step (any AEs) formulary, and \$648.7 million higher in the presorted formulary, relative to the open formulary (Figure 3). Although there were fewer renal AEs across all scenarios, treatment costs for renal events were much higher than for bone fractures, leading to greater overall total costs.

Inpatient costs incurred by a renal event or bone fracture were the largest component of the cumulative costs in 2016-2025,

representing 52% and 48%, respectively (Table). Office-based provider costs were the second largest component, comprising 35% of renal AE costs and 19% of bone fracture AE costs. These 2 components alone represented \$1.2 billion in cumulative costs in the open formulary, \$1.7 billion in the presorted formulary, and slightly more than \$3.0 billion in the step (any AEs) and step (renal) scenarios over 10 years (Table).

### Second-Line Therapy

In more restrictive scenarios, considerably more people switched to a second-line treatment of PI/2NRTIs compared with the less restrictive formularies. In 2025, about 58,000 patients in the 3 most restrictive formularies were on a second-line regimen because of virologic failure. In contrast, an estimated 41,000 patients in the presorted formulary and 27,000 patients in the open formulary, were on the second-line regimen due to virologic failure.

### Deaths

Compared with the open formulary, restricting access to HIV treatments led to 16,200 more deaths, on average, in the more restrictive formularies by 2025 (Figure 1). The presorted formulary resulted in about 7300 more cumulative deaths by 2025 than the open formulary.

## DISCUSSION

Our findings illustrate that a scenario that matches the distribution of treatments observed in a treatment-naïve HIV population that obtains a high degree of access to available treatments—Ryan White patients—significantly reduces AE treatment costs and mortality rates relative to more restrictive formulary designs. These results are driven by a greater initial utilization of therapies with better efficacy and AE profiles in our open design, along with sorting patients who are predisposed to certain AEs to more tolerable regimens. The open design outperforms the presorted design because even more patients are started on the newer TAF-based therapy, which has demonstrated lower rates of serious AEs and improved efficacy.<sup>37</sup> Compared with the open formulary, we estimated that the average restrictive formulary design, which initiates fewer people on therapies with better efficacy and safety profiles and allows switching to those therapies only under particular circumstances, would result in \$2.28 billion in additional healthcare costs over 10 years and 3.5% more deaths of patients with HIV.

Although step therapy approaches aim to reduce the costs of treatment by prioritizing less-costly regimens, in practice, the number of people receiving non-STR therapies may contribute to future increases in healthcare costs.<sup>38</sup> Our analysis, which incorporates a second-line multitablet regimen (MTR) therapy in the event of virologic failure on a first-line treatment, complements other research findings that STRs are associated with lower per patient healthcare and hospitalization costs compared with MTRs.<sup>39</sup>

**FIGURE 2.** Annual Number of Renal Events and Bone Fractures (2016–2025)

**A.** Number of renal failures per year, 2016–2025, across formularies

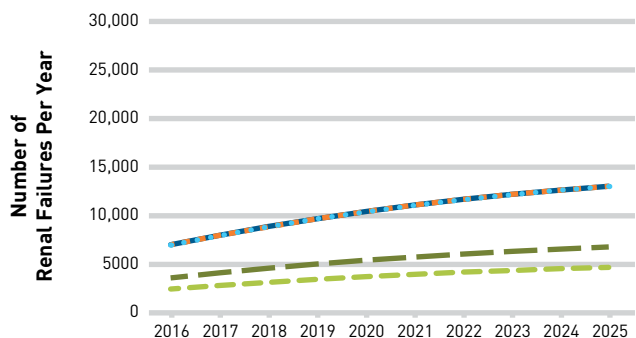

**B.** Number of bone fractures per year, 2016–2025, across formularies

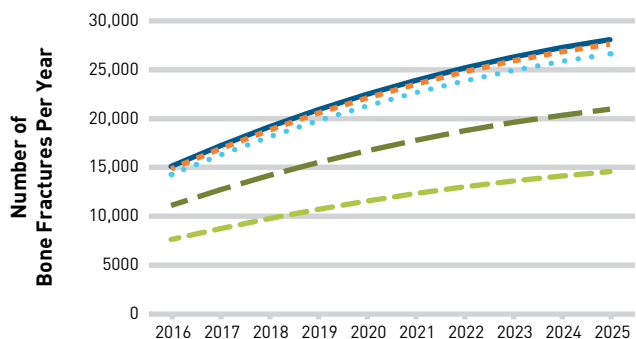

— Most Restrictive Formulary      - - - Step Therapy (Renal AEs)  
 ···· Step Therapy (Any AEs)      - - - Presorted on Patient Tendencies  
 - - - Open Formulary

AE indicates adverse event.

Fewer cumulative all-cause deaths in the less restrictive formulary scenarios are attributable to several factors. First, more patients are receiving more efficacious regimens. Second, lower AE rates for those on the TAF-based therapy result in fewer patients switching regimens. Using values for a statistical life reported in the literature, the discounted value of the additional lives saved over 10 years in the open formulary versus the more restrictive formularies ranges from \$58 billion to \$188 billion, depending on the value of a statistical life used (\$4.3 million, \$9.2 million, or \$13.8 million in 2016 US\$).<sup>40</sup> This implies that additional spending in that range is justified by a standard social value criterion of the benefits exceeding the costs (based only on lives saved, and excluding savings from reduced AEs).

### Policy Implications

Our findings demonstrate that policies that reduce patient access to HIV regimens with better outcomes in terms of efficacy, AE

**FIGURE 3.** Cumulative Treatment Costs of Renal Events and Bone Fractures (2016-2025)

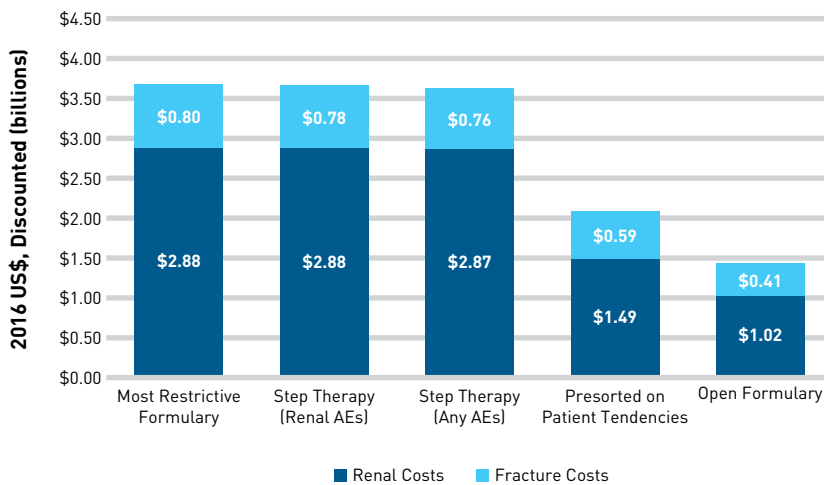

AE indicates adverse event.

**TABLE.** Cumulative Treatment Costs of Bone and Renal AEs by Component (2016-2025)

Category of Care	Formulary				
	Most Restrictive	Step (renal AEs)	Step (any AEs)	Presorted	Open
<b>Renal AEs (2016 US\$, discounted millions)</b>					
Inpatient hospital	1483.4	1482.3	1479.2	768.3	528.0
Outpatient hospital	224.4	224.2	223.7	116.2	79.9
Emergency department	6.9	6.9	6.9	3.6	2.5
Office-based provider	1017.6	1016.9	1014.7	527.1	362.2
Prescriptions	147.0	146.9	146.6	76.2	52.3
<b>TOTAL</b>	<b>2879.4</b>	<b>2877.1</b>	<b>2871.2</b>	<b>1491.4</b>	<b>1024.9</b>
<b>Fracture AEs (2016 US\$, discounted millions)</b>					
Inpatient hospital	385.0	378.8	364.7	286.0	198.1
Outpatient hospital	91.8	90.3	86.9	68.2	47.2
Emergency department	73.2	72.0	69.3	54.4	37.7
Office-based provider	154.8	152.2	146.6	115.0	79.6
Prescriptions	92.5	91.0	87.6	68.7	47.6
<b>TOTAL</b>	<b>797.2</b>	<b>784.3</b>	<b>755.2</b>	<b>592.3</b>	<b>410.1</b>

AE indicates adverse event.

profiles, or adherence can have significant health and economic consequences. Some Medicaid plans have used preferred drug lists (PDLs), requiring a prescriber to receive prior authorization (PA) from the plan, and some health insurance Marketplace insurers have used restrictive formulary designs for HIV therapies.<sup>41-44</sup> Our analysis suggests that the implications of such restrictions should be carefully considered. Effects on outcomes depend on

the specific drugs chosen and the nature of the restrictions. With respect to Medicare, our analysis illustrates the possible benefits from the protected class status that CMS has always maintained for antiretroviral drugs, ruling out closed formularies, limiting utilization management strategies, and expediting formulary review.

**Limitations**

Our study has several limitations. First, our model included some simplifying assumptions. For example, we assumed a uniform progression rate between stages 1 and 4 for treated patients that is intended to capture net progression, thereby embedding immunological recovery due to treatment. We did, however, calibrate our model so that key outputs were consistent with projections from a more complex published model. This approach may have resulted in an under- or overestimation of the projected burden of HIV. Second, although we varied transmission rates for untreated versus treated patients, we did not vary transmission rates by infection stage and instead used average rates based on the literature. This simplification might understate the outcome differences across the scenarios because transmission by treated patients would be relatively lower for formulary designs that generate better efficacy.

Third, the treatment efficacy parameters were based primarily on clinical trial data, which may not match real-world outcomes. Fourth, we focused only on fractures and renal AEs in our analysis. Thus, the cost differences across formularies would be greater if the frequencies of other events are, on balance, correlated with those included here. Certain cardiovascular events have been associated with ABC/DTG/3TC because of the abacavir component,<sup>45</sup> but they were not included in our analysis because their occurrence was not explicitly analyzed in the clinical trials used in our model.

Fifth, the model did not incorporate effects of an aging population due to the limited follow-up of patients involved in the clinical trials used in this study. Also, the median age of patients in the trial data ranged from 33 to 38 years, while the median age of patients with HIV is above 45 years.<sup>19,27,46</sup> Because the risk of osteopenia and osteoporosis in patients with HIV increases with age, as does the

risk of fractures, it is reasonable to think that the differences among the formularies in terms of AE costs and rates will be greater than our modeling indicates and may increase as the population ages and patients spend more time on HIV regimens.<sup>47-49</sup> Additionally, there may be varying quality-of-life effects experienced by an aging population that we did not capture.

Sixth, we acknowledge that, in practice, the definition of step therapy could vary across health plans. Our chosen formulary designs reflect a range of access restrictions. For example, a tiered co-payment design bears similarities to step designs: A preferred drug with a low co-pay is likely to be prescribed first, with movement to a higher-tier drug in the case of treatment failure or serious AE. There is also similarity between the use of PDLs or PA requirements and step therapy designs.

Finally, our characterization of an "open" formulary may be overly optimistic. Although the scenario matched the real-world utilization rates for therapies that have been observed in a treatment-naïve population facing low or no co-pays, we assumed that all patients with low kidney function or osteopenia were among those started on either TAF- or ABC-based regimens. Although this characterization captures the view that providers will sort patients to the most appropriate regimens, to the extent that they fail in this regard, outcomes will not be as favorable.

## CONCLUSIONS

The findings from this study suggest that less restrictive formulary designs, which allow providers to start patients with HIV/AIDS on different regimens based on their proclivity to AEs (and result in more people using a TAF-based regimen, which is more effective and has a better AE profile), yield better outcomes and reduce AE treatment costs compared with more restrictive step therapy formularies. Although tiered co-pay designs and other utilization management strategies were not directly studied here, a similar impact on the sequencing of therapies for patients suggests that these practices would likely also result in suboptimal patient outcomes. ■

**Author Affiliations:** Precision Health Economics (JB, CH, MK, LY, JC), Los Angeles, CA; Leonard D. Schaeffer Center for Health Policy and Economics, University of Southern California (JR), Los Angeles, CA.

**Source of Funding:** Funding for this study was provided by Gilead Sciences to Precision Health Economics.

**Author Disclosures:** Dr Baumgardner, Ms Huber, Dr Kabiri, Ms Yoon, and Ms Chou are employees of Precision Health Economics, which received financial support for this research from Gilead Sciences. Dr Romley is a consultant to Precision Health Economics.

**Authorship Information:** Concept and design (JB, CH, MK, LY, JR); acquisition of data (CH, LY); analysis and interpretation of data (JB, CH, MK, LY, JR); drafting of the manuscript (JB, CH, MK, LY, JC); critical revision of the manuscript for important intellectual content (JB, CH, JC, JR); statistical analysis (JB, MK); administrative, technical, or logistic support (CH, MK, LY, JC); and supervision (JB).

**Address Correspondence to:** James Baumgardner, PhD, Precision Health Economics, 11100 Santa Monica Blvd, Ste 500, Los Angeles, CA 90026. Email: james.baumgardner@precisionhealththeconomics.com.

## REFERENCES

- Panel on Antiretroviral Guidelines for Adults and Adolescents. *Guidelines for the Use of Antiretroviral Agents in HIV-1-Infected Adults and Adolescents*. Washington, DC: HHS; 2016. [aidsinfo.nih.gov/guidelines](https://aidsinfo.nih.gov/guidelines). Accessed July 14, 2015.
- Bartlett JG. Ten years of HAART: foundation for the future. Paper presented at: 13th Conference on Retroviruses and Opportunistic Infections; February 5-8, 2006; Denver, CO. [medscape.com/viewarticle/523119](https://www.medscape.com/viewarticle/523119). Accessed August 7, 2017.
- Aldir I, Horta A, Serrado M. Single-tablet regimens in HIV: does it really make a difference? *Curr Med Res Opin*. 2014;30(1):89-97. doi: 10.1185/03007995.2013.844685.
- Bangsberg DR, Ragland K, Monk A, Deeks SG. A single tablet regimen is associated with higher adherence and viral suppression than multiple tablet regimens in HIV+ homeless and marginally housed people. *AIDS*. 2010;24(18):2835-2840. doi: 10.1097/QAD.0b013e3181a57209.
- Clumeck N, Molina JM, Henry K, et al: GS-236-0103 Study Team. A randomized, double-blind comparison of single-tablet regimen elvitegravir/cobicistat/emtricitabine/tenofovir DF vs ritonavir-boosted atazanavir plus emtricitabine/tenofovir DF for initial treatment of HIV-1 infection: analysis of week 144 results. *J Acquir Immune Defic Syndr*. 2014;65(3):e121-e124. doi: 10.1097/QAI.000000000000089.
- Dejesus E, Young B, Morales-Ramirez JO, et al: AI266073 Study Group. Simplification of antiretroviral therapy to a single-tablet regimen consisting of efavirenz, emtricitabine, and tenofovir disoproxil fumarate versus unmodified antiretroviral therapy in virologically suppressed HIV-1-infected patients. *J Acquir Immune Defic Syndr*. 2009;51(2):163-174. doi: 10.1097/QAI.0b013e3181a572cf.
- What is the HIV care continuum? HIV.gov website. [hiv.gov/federal-response/policies-issues/hiv-aids-care-continuum](http://hiv.gov/federal-response/policies-issues/hiv-aids-care-continuum). Updated December 30, 2016. Accessed April 6, 2017.
- HIV Surveillance Report, 2016*. Atlanta, GA: CDC; 2016. [cdc.gov/hiv/pdf/library/reports/surveillance/cdc-hiv-surveillance-report-us.pdf](https://www.cdc.gov/hiv/pdf/library/reports/surveillance/cdc-hiv-surveillance-report-us.pdf). Accessed April 6, 2017.
- Goldman DP, Joyce GF, Zheng Y. Prescription drug cost sharing: associations with medication and medical utilization and spending and health. *JAMA*. 2007;298(11):61-69. doi: 10.1001/jama.298.1.61.
- HMO formulary. Kaiser Permanente website. [health.kaiserpermanente.org/static/health/pdfs/formulary/mid/mid\\_hmo\\_formulary.pdf](https://www.health.kaiserpermanente.org/static/health/pdfs/formulary/mid/mid_hmo_formulary.pdf). Updated March 6, 2018. Accessed October 5, 2016.
- Your 2016 prescription drug list. UnitedHealthcare website. [myuhc.com/content/myuhc/Member/Assets/Pdfs/100-16910\\_FS\\_3T\\_Adv\\_PDL\\_116\\_6.pdf](https://myuhc.com/content/myuhc/Member/Assets/Pdfs/100-16910_FS_3T_Adv_PDL_116_6.pdf). Published 2016. Accessed October 5, 2016.
- Zamani-Hank Y. The Affordable Care Act and the burden of high cost sharing and utilization management restrictions on access to HIV medications for people living with HIV/AIDS. *Popul Health Manag*. 2016;19(4):272-278. doi: 10.1089/pop.2015.0076.
- Schaefer KL. The importance of treatment adherence in HIV. *Am J Manag Care*. 2013;19(suppl.12):S231-S237.
- Kesselheim AS, Huybrechts KF, Choudhry NK, et al. Prescription drug insurance coverage and patient health outcomes: a systematic review. *Am J Public Health*. 2015;105(2):e17-e30. doi: 10.2105/AJPH.2014.302240.
- Bloch M, Tong WW, Hoy J, et al: TROP (Switch from Tenofovir to Raltegravir for Low Bone Density) Study Team. Switch from tenofovir to raltegravir increases low bone mineral density and decreases markers of bone turnover over 48 weeks. *HIV Med*. 2014;15(6):373-380. doi: 10.1111/hiv.12123.
- d'Arminio Monforte A, Lepri AC, Rezza G, et al. Insights into the reasons for discontinuation of the first highly active antiretroviral therapy (HAART) regimen in a cohort of antiretroviral naive patients. I.CO.N.A. Study Group. Italian Cohort of Antiretroviral-Naive Patients. *AIDS*. 2000;14(5):499-507.
- O'Brien ME, Clark RA, Besch CL, Myers L, Kissinger P. Patterns and correlates of discontinuation of the initial HAART regimen in an urban outpatient cohort. *J Acquir Immune Defic Syndr*. 2003;34(4):407-414.
- Sax PE, Wohl D, Yin MT, et al: GS-US-292-0104/0111 Study Team. Tenofovir alafenamide versus tenofovir disoproxil fumarate, coformulated with elvitegravir, cobicistat, and emtricitabine, for initial treatment of HIV-1 infection: two randomised, double-blind, phase 3, non-inferiority trials. *Lancet*. 2015;385(9987):2606-2615. doi: 10.1016/S0140-6736(15)00616-X.
- Sax PE, Zolopa A, Brar I, et al. Tenofovir alafenamide vs. tenofovir disoproxil fumarate in single tablet regimens for initial HIV-1 therapy: a randomized phase 2 study. *J Acquir Immune Defic Syndr*. 2014;67(1):52-58. doi: 10.1097/QAI.0000000000000225.
- Winston J, Chonchol M, Gallant J, et al. Discontinuation of tenofovir disoproxil fumarate for presumed renal adverse events in treatment-naïve HIV-1 patients: meta-analysis of randomized clinical studies. *HIV Clin Trials*. 2014;15(6):231-245. doi: 10.1310/hct1506-231.
- Woodward CL, Hall AM, Williams IG, et al. Tenofovir-associated renal and bone toxicity. *HIV Med*. 2009;10(8):482-487. doi: 10.1111/j.1468-1293.2009.00716.x.
- Yuan Y, L'Italien G, Mukherjee J, Iloeje UH. Determinants of discontinuation of initial highly active antiretroviral therapy regimens in a US HIV-infected patient cohort. *HIV Med*. 2006;7(3):156-162. doi: 10.1111/j.1468-1293.2006.00355.x.
- Cooper RD, Wiebe N, Smith N, Keiser P, Naicker S, Tonelli M. Systematic review and meta-analysis: renal safety of tenofovir disoproxil fumarate in HIV-infected patients. *Clin Infect Dis*. 2010;51(5):496-505. doi: 10.1093/cid/cir161.
- Granic RM, Gilks CF, Dye C, De Cock KM, Williams BG. Universal voluntary HIV testing with immediate antiretroviral therapy as a strategy for elimination of HIV transmission: a mathematical model. *Lancet*. 2009;373(9657):48-57. doi: 10.1016/S0140-6736(08)1697-9.
- Romley JA, Juday T, Solomon MD, Seekins D, Brookmeyer R, Goldman DP. Early HIV treatment led to life expectancy gains valued at \$80 billion for people infected in 1996-2009. *Health Aff (Millwood)*. 2014;33(3):370-377. doi: 10.1377/hlthaff.2013.0623.
- Behavioral and Clinical Characteristics of Persons Receiving Medical Care for HIV Infection—Medical Monitoring Project, United States, 2014 Cycle (June 2014–May 2015)*. Atlanta, GA: CDC; 2016. [cdc.gov/hiv/pdf/library/reports/surveillance/cdc-hiv-hssr-mmp-2014.pdf](https://www.cdc.gov/hiv/pdf/library/reports/surveillance/cdc-hiv-hssr-mmp-2014.pdf). Accessed April 6, 2017.
- CDC. Monitoring selected national HIV prevention and care objectives by using HIV surveillance data—United States and 6 dependent areas—2015. *HIV/AIDS Surveill Suppl Rep*. 2017;22(2). [cdc.gov/hiv/pdf/library/reports/surveillance/cdc-hiv-surveillance-supplemental-report-vol-22-2.pdf](https://www.cdc.gov/hiv/pdf/library/reports/surveillance/cdc-hiv-surveillance-supplemental-report-vol-22-2.pdf). Accessed April 6, 2017.
- Hall HI, Holtgrave DR, Tang T, Rhodes P. HIV transmission in the United States: considerations of viral load, risk behavior, and health disparities. *AIDS Behav*. 2013;17(5):1632-1636. doi: 10.1007/s10461-013-0426-z.
- Skarbinski J, Rosenberg E, Paz-Bailey G, et al. Human immunodeficiency virus transmission at each step of the care continuum in the United States. *JAMA Intern Med*. 2015;175(4):588-596. doi: 10.1001/jamainternmed.2014.8180.
- Data on file. Percentage of TAF share among antiretroviral-naïve Ryan White patients in Q2 2016 *Ipsos HIV US Scope Q2 2016*. Ipsos; 2016.
- Faruki H, Heine U, Brown T, Koester R, Lai-Goldman M. HLA-B\*5701 clinical testing: early experience in the United States. *Pharmacogenet Genomics*. 2007;17(10):857-860. doi: 10.1097/FPC.0b013e3181a572de.

## ORIGINAL RESEARCH

32. Mallat S, Phillips E, Carosi G, et al; PREDICT-1 Study Team. HLA-B\*5701 screening for hypersensitivity to abacavir. *N Engl J Med*. 2008;358(6):568-579. doi: 10.1056/NEJMoa0706135.
33. Small C, Wohl D, Margolis DA, et al. Prevalence of HLA-B\*5701 allele in HIV-infected subjects in North America and reductions in risk for development of abacavir associated hypersensitivity reaction. Paper presented at: 52nd International Conference on Antimicrobial Agents and Chemotherapy; September 9-12, 2012; San Francisco, CA. [natap.org/2012/ICAAC/ICAAC\\_16.htm](http://natap.org/2012/ICAAC/ICAAC_16.htm). Accessed July 24, 2017.
34. Medical Expenditure Panel Survey: household component event files. Agency for Healthcare Research and Quality website. [meps.ahrq.gov/data\\_stats/download\\_data\\_files.jsp](https://meps.ahrq.gov/data_stats/download_data_files.jsp). Accessed October 1, 2015.
35. Russell LB, Gold MR, Siegel JE, Daniels N, Weinstein MC. The role of cost-effectiveness analysis in health and medicine. *JAMA*. 1996;276(14):1172-1177. doi: 10.1001/jama.1996.03540140060028.
36. Shah M, Perry A, Risher K, et al. Effect of the US National HIV/AIDS Strategy targets for improved HIV care engagement: a modelling study. *Lancet HIV*. 2016;3(3):e140-e146. doi: 10.1016/S2352-3018(16)00007-2.
37. Wang H, Lu X, Yang X, Xu N. The efficacy and safety of tenofovir alafenamide versus tenofovir disoproxil fumarate in antiretroviral regimens for HIV-1 therapy: meta-analysis. *Medicine (Baltimore)*. 2016;95(41):e5146. doi: 10.1097/MD.0000000000005146.
38. Carlton RI, Bramley TJ, Nightengale B, Conner TM, Zacker C. Review of outcomes associated with formulary restrictions: focus on step therapy. *Am J Pharm Benefits*. 2010;2(1):50-58.
39. Cohen CJ, Meyers JL, Davis KL. Association between daily antiretroviral pill burden and treatment adherence, hospitalisation risk, and other healthcare utilisation and costs in a US Medicaid population with HIV. *BMJ Open*. 2013;3(8):e003028. doi: 10.1136/bmjopen-2013-003028.
40. Robinson LA, Hammitt JK. Valuing reductions in fatal illness risks: implications of recent research. *Health Econ*. 2016;25(8):1039-1052. doi: 10.1002/hec.3214.
41. Andrews M. 7 insurers alleged to use skimpy drug coverage to discourage HIV patients. Kaiser Health News website. [khn.org/news/7-insurers-alleged-to-use-skimpy-drug-coverage-to-discourage-hiv-patients](http://khn.org/news/7-insurers-alleged-to-use-skimpy-drug-coverage-to-discourage-hiv-patients). Published October 18, 2016. Accessed April 3, 2017.
42. Preferred drug list: Illinois Medicaid. Illinois Department of Healthcare and Family Services website. [illinois.gov/hfs/SiteCollectionDocuments/January2017PDL.pdf](http://illinois.gov/hfs/SiteCollectionDocuments/January2017PDL.pdf). Published January 1, 2017. Accessed March 30, 2017.
43. Preferred drug list. Mississippi Division of Medicaid website. [medicaid.ms.gov/providers/pharmacy/preferred-drug-list](http://medicaid.ms.gov/providers/pharmacy/preferred-drug-list). Accessed March 30, 2017.
44. Patient access to HIV drugs in exchange plans is limited compared to other sources of coverage [news release]. Washington, DC: Avalere Health; November 11, 2015. [avalere.com/expertise/managed-care/insights/patient-access-to-hiv-drugs-in-exchange-plans-is-limited-compared-to-other](http://avalere.com/expertise/managed-care/insights/patient-access-to-hiv-drugs-in-exchange-plans-is-limited-compared-to-other). Accessed April 3, 2017.
45. Marcus JL, Neugebauer RS, Leyden WA, et al. Use of abacavir and risk of cardiovascular disease among HIV-infected individuals. *J Acquir Immune Defic Syndr*. 2016;71(4):413-419. doi: 10.1097/QAI.0000000000000881.
46. Sax PE, DeJesus E, Mills A, et al; GS-US-236-0102 Study Team. Co-formulated elvitegravir, cobicistat, emtricitabine, and tenofovir versus co-formulated efavirenz, emtricitabine, and tenofovir for initial treatment of HIV-1 infection: a randomised, double-blind, phase 3 trial, analysis of results after 48 weeks. *Lancet*. 2012;379(9835):2439-2448. doi: 10.1016/S0140-6736(12)60917-9.
47. Carr A, Grund B, Neuhaus J, et al; International Network for Strategic Initiatives in Global HIV Trials (INSIGHT) START Study Group. Prevalence of and risk factors for low bone mineral density in untreated HIV infection: a substudy of the INSIGHT Strategic Timing of Antiretroviral Treatment (START) trial. *HIV Med*. 2015;16(suppl 1):137-146. doi: 10.1111/hiv.12242.
48. Hilleman CO, Eckard AR, McComsey GA. Bone loss in HIV: a contemporary review. *Curr Opin Endocrinol Diabetes Obes*. 2015;22(6):446-451. doi: 10.1097/MED.0000000000000200.
49. Nasi M, De Biasi S, Gibellini L, et al. Ageing and inflammation in patients with HIV infection. *Clin Exp Immunol*. 2017;187(1):44-52. doi: 10.1111/cei.12814.

Full text and PDF at [www.ajmc.com](http://www.ajmc.com)

## eAppendix: Modeling the Impacts of Restrictive Formularies on HIV Patient Outcomes

### eAppendix A. Description of Epidemiological Model

#### Conceptual Model

We adapted an epidemiological model of human immunodeficiency virus (HIV) transmission and progression first described by Granich, et al (2009) to evaluate the health and economic impacts of formulary restrictions to HIV treatments.<sup>1,2</sup> The model was adapted to the United States setting by Goldman et al (2014) to assess the effects of early access to antiretroviral therapy (ART) for HIV patients.<sup>1</sup> eAppendix Figure 1 and eAppendix Table 1 show the model schematics. The population of uninfected individuals, who were susceptible to HIV through sexual transmission, was represented by  $S$  in the figure. Births, determined by the population size ( $N$ ) and birth rate ( $\beta$ ), repopulated the susceptible population. We used the Centers for Disease Control and Prevention's (CDC's) four disease classifications as the disease stages through which patients progressed<sup>3</sup>, identified by index  $i = \{1,2,3,4\}$ . Disease stages were defined based on cluster of differentiation 4 (CD4) count:  $\geq 500$  cells/mm<sup>3</sup> (Stage 1), 350–499 cells/mm<sup>3</sup> (Stage 2), 200–349 cells/mm<sup>3</sup> (Stage 3), and 0–199 cells/mm<sup>3</sup> (Stage 4). Once infected with HIV, individuals progressed untreated to the first disease stage, as indicated by the box  $I_1$ . Infected individuals would further progress untreated to the more advanced stages of disease, which was determined by  $\rho_i$ , the untreated rate of progression by disease stage. Alternatively, individuals in each disease stage could be treated according to a treatment initiation rate and transition to a treated state indicated by box  $A_i$ . We assumed similar rates of treatment initiation in each disease stage ( $\tau = 0.15$ ) regardless of formulary scenario (see eAppendix Table 2 for parameter values). Once in a treated state, infected individuals might discontinue treatment and progress into the infected untreated disease stage at a rate indicated by  $\phi$ . Treatment discontinuation rate was adjusted according to each HIV treatment formulary scenario, but was assumed the same for each disease stage within each formulary (eAppendix Table 3). Conversely, patients might continue on treatment but progress between the disease stages 1–4 at a calibrated rate of 0.046 indicated by  $\sigma$ . Patients could only flow out of the model because of death. Causes of death could be from acquired immune deficiency syndrome (AIDS), as indicated by  $D$ , due to progression from stage 4 (AIDS) to death at a rate of 0.1187 indicated by



$\sigma_D$ , or by another cause, as indicated by  $\mu$ , which was equivalent to the average United States mortality rate for the age 25–44 population of 0.00138.

We developed five hypothetical formulary scenarios described in the following sections. We ran the model separately for each scenario to generate the outcomes of interest. Under all scenarios, patients in the treatment states ( $A_i$ ) could switch regimens due to renal failure or fracture adverse events, or virologic failure, or discontinue treatment and transition to the corresponding non-treated state.

We initiated our model in 2016. Each model cycle lasted 1 year (52 weeks), and we used a ten-year horizon for our analyses.

### Incidence, Prevalence and Infectivity

The incidence of new HIV cases depended on the infectivity of currently infected individuals. Treated HIV patients with a low viral load were much less likely to infect susceptible individuals than are HIV patients with a high viral load. HIV transmission was accounted for by considering an incidence rate rather than simulating the interactions between HIV-infected and susceptible individuals. We used an infectivity parameter of 0.05 according to the literature, indicating that a treated person was only 5% as likely to transmit the disease as an untreated person.<sup>4-6</sup> Patients who remained on highly effective treatment subsequently had lower viral loads and infectivity. Conversely, patients who did not respond to treatment or discontinued treatment because of an adverse event or other reason would likely have higher viral loads and greater infectivity. As HIV is transferred through sexual activity in this model, we used the number of men who have sex with men (MSM) in the United States, 4.3 million, as a proxy for the susceptible population at the start of our model, in 2016.<sup>7</sup> While this estimate did not incorporate heterosexual men and women (14% and 17% of new HIV diagnoses, respectively), MSM represented an increasing majority of new HIV infections.<sup>8</sup>

According to estimates from the CDC, 1.1 million individuals were infected with HIV in the United States in 2015.<sup>9,10</sup> To derive the population that receives treatment in the model, we multiplied the size of the HIV population by the estimated percentage of HIV patients who were on continuous treatment (48%) to generate our initial treated population.

We stratified all HIV-infected individuals into four disease stages according to the CDC's 2015 Medical Monitoring Report. The report estimated that 49.2%, 22.9%, 15.8%, and 12.1% of

all HIV patients were in HIV stages 1–4, respectively.<sup>11</sup> We used these estimates to assign the initial disease stages to the HIV-infected population in 2016.

**eAppendix Figure 1. Conceptual Framework of HIV transmission Model\***

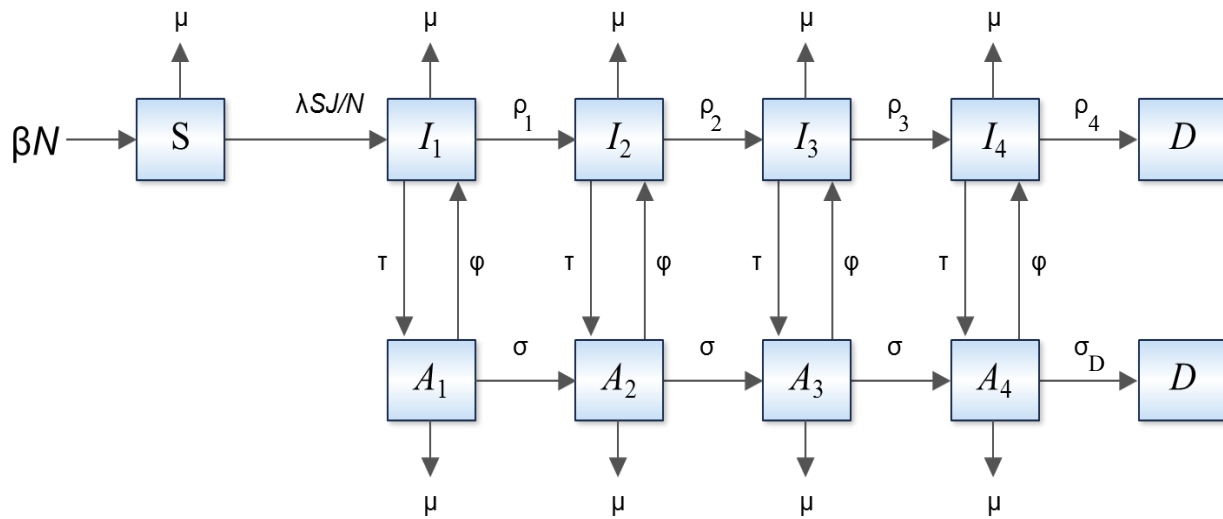

**Conceptual Model of Regimen Switching**

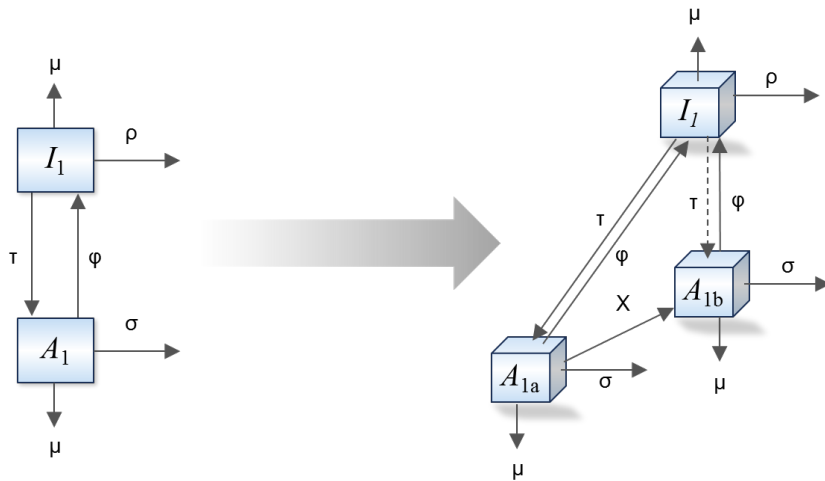

\* Our epidemiological model was based on two previously published epidemiological models by Granich et al.<sup>2</sup> and Goldman et al.<sup>1</sup>

**eAppendix Table 1.** Parameters for HIV Epidemiological Model

Parameter	Description <sup>2</sup>
$i$	HIV stage based on CD4 count: $\geq 500$ cells/mm <sup>3</sup> : Stage 1: $\geq 500$ cells/mm <sup>3</sup> Stage 2: 350-499 cells/mm <sup>3</sup> Stage 3: 200-349 cells/mm <sup>3</sup> Stage 4: 0-199 cells/mm <sup>3</sup>
$\beta$	Rate of inflow into susceptible compartment
$N$	Population
$S$	Susceptible compartment
$\lambda SJ/N$	Rate at which infection occurs
$\lambda = \lambda_0 e^{-\alpha(N-S/N)^n}$	Transmission parameter, calibrated $\alpha$ and $n$ : parameters that account for heterogeneity in sexual behavior
$J = \sum i(I_i + \varepsilon A_i)$	Total number of people in infected compartments. $\varepsilon$ allows for a reduction in the infectiousness of the people receiving ART, $i = 1, \dots, 4$
$I_i$	Compartment corresponding to non-treated population in HIV stage $i$ , $i = 1, \dots, 4$
$A_i$	Compartment corresponding to treated population in HIV stage $i$ , $i = 1, \dots, 4$
$D$	Death compartment
$\sigma$	HIV progression rate for treated population between stages 1–4
$\sigma_D$	HIV progression rate for treated population between stage 4 (AIDS) to death
$\tau$	Rate of treatment initiation
$\varphi$	Combined rate of treatment discontinuation
$\rho_i$	HIV progression rate for non-treated population, $i$ $= 1, \dots, 4$
$\mu$	Background (all-cause) mortality rate

**eAppendix Table 2. Model Parameters**

Parameter	Value	Source
<b>Population and Model Inputs</b>		
Starting susceptible population in 2016	4,300,000	7
Starting infected population in 2016	1,120,000	11
Disease stage distribution among treated: proportion of total infected population		
Stage 1 <sup>a</sup>	0.177	11
Stage 2	0.082	
Stage 3	0.057	
Stage 4	0.044	
Disease stage distribution among untreated: proportion of total infected population		
Stage 1 <sup>a</sup>	0.315	1,12-13
Stage 2	0.147	
Stage 3	0.101	
Stage 4	0.077	
Mortality rate	0.00138	14
Birth rate	0.018	15
Infectivity rate	0.05	5,7
Age threshold for sexual transmission, years	13	10
Average age at infection, years	35.5	11
Disease progression rate among untreated ( $\rho$ ) calibrated		
Stage 1 to stage 2 <sup>a</sup>	0.249	
Stage 2 to stage 3	0.305	
Stage 3 to stage 4	0.490	
Stage 4 to death	0.540	
Disease progression rate between stages 1-4 among treated ( $\sigma$ ) <sup>b</sup>		1
Base value	0.0460	
Most restrictive	0.0460	
Step therapy any AEs	0.0460	
Step therapy renal	0.0459	
Presorted	0.0446	
Open	0.0439	
Disease progression rate from stage 4 to death among treated ( $\sigma_D$ ) <sup>b</sup>		13, 16
Base value	0.1187	
Most restrictive	0.1187	
Step therapy any AEs	0.1187	
Step therapy renal	0.1185	
Presorted	0.1151	

Open	0.1133	
Baseline prevalence of comorbidities		
Osteopenia	0.351	17
Renal impairment	0.062	18
Baseline prevalence of HLA-B*5701 allele (%)	5.5	19-21
<b>Event Rates</b>		
<b>Treatment efficacy</b>		
First-line therapy, no pre-existing condition <sup>c</sup>		
EVG/COBI/FTC/TDF	0.890	22-24
FTC/RPV/TDF	0.840	25,26
ABC/DTG/3TC	0.880	27
TAF-based regimen	0.920	24
First- or second-line therapy, renally impaired <sup>c</sup> population		
EVG/COBI/FTC/TDF	0.790	28
TAF-based regimen	0.920	29
First- or second-line therapy, low BMD <sup>d</sup> population		
TAF-based regimen	0.970	30
ABC/DTG/3TC	0.850	31
Second-line therapy, virologic failure		
PI+ 2 NRTIs	0.710	32
<b>Treatment failure</b>		
First-line therapy, no pre-existing condition		
EVG/COBI/FTC/TDF	0.050	33
FTC/RPV/TDF	0.080	34
TAF-based regimen	0.036	24
ABC/DTG/3TC	0.040	27
First-line therapy, renally impaired population		
TDF-based regimen	0.030	35
TAF-based regimen	0.010	35
First- or second-line therapy, low BMD population		
TDF-based regimen	0.030	29
TAF-based regimen	0.010	30
ABC/DTG/3TC	0	-
Second-line therapy, virologic failure		
PI+ 2 NRTIs	0.065	32
<b>Treatment discontinuation</b>		
No pre-existing condition		
EVG/COBI/FTC/TDF (first-line therapy)	0.060	23
FTC/RPV/TDF (first-line therapy)	0.051	25
TDF-based regimen (second-line therapy)	0.075	29
TAF-based regimen	0.040	24
ABC/DTG/3TC (first-line therapy)	0.065	27

ABC/DTG/3TC (second-line therapy)	0.010	Assumption
PI+ 2 NRTIs (second-line therapy)	0.210	32
<b>Treatment discontinuation due to AE</b>		
No pre-existing condition		
EVG/COBI/FTC/TDF	0.028	22-24
FTC/RPV/TDF	0.034	25
TAF-based regimen	0.010	24
ABC/DTG/3TC	0.024	27
Renally impaired population		
TDF-based regimen <sup>e</sup>	0.120	28
TAF-based regimen	0.110	35
Low BMD population		
TAF-based regimen	0.010	31
ABC/DTG/3TC	0.040	31
<b>Adverse event</b>		
Bone fracture, no pre-existing condition		
TDF-based regimen	0.0325	23, 36, 37
TAF-based regimen	0.0012	24
ABC/DTG/3TC	0.0150	27
Bone fracture, second-line therapy, no pre-existing condition		
PI+ 2 NRTIs	0.0150	38
Bone fracture, renally impaired population		
TDF-based regimen	0.0325	29
TAF-based regimen	0.0250	35
Bone fracture, low BMD population		
TAF-based regimen	0	30
ABC/DTG/3TC	0.0186	39
Renal AE, no pre-existing condition		
EVG/COBI/FTC/TDF	0.0100	24
FTC/RPV/TDF	0.0100	Assumption
ABC/DTG/3TC	0	27
PI+ 2 NRTIs	0.0150	38
Renal AE, second-line therapy healthy population		
TDF-based regimen	0.0030	29
Renal AE, renally impaired population		
TDF-based regimen	0.0900	28
TAF-based regimen	0.0800	35
Renal AE, low BMD population		
TAF-based regimen	0.0020	30
ABC/DTG/3TC	0.0036	39

ABC/DTG/3TC indicates abacavir/dolutegravir/lamivudine; AE, adverse event; BMD, bone mineral density; EVG/COBI/FTC/TAF, elvitegravir/cobicistat/ emtricitabine/tenofovir alafenamide; EVG/COBI/FTC/TDF, elvitegravir/cobicistat/emtricitabine/tenofovir disoproxil fumarate; FTC/RPV/TDF, emtricitabine/rilpivirine/tenofovir disoproxil fumarate.

<sup>a</sup>Stage 1, CD4+  $\geq 500$  cells/mL; stage 2, CD4+ 350-499 cells/mL; stage 3, CD4+ 200-349 cells/mL; stage 4, CD4+ 0-199 cells/mL.

<sup>b</sup> $\sigma$  were used for all disease progression transitions between stages 1 and 4 within each formulary scenario. The base values of  $\sigma$  and  $\sigma_D$  were based on the reference, and then adjusted by the authors based on the relative efficacies and discontinuation rates between formularies.

<sup>c</sup>Pre-existing conditions: renal impairment or osteopenia. Renal impairment defined as estimated glomerular filtration rate Cockcroft-Gault (eGFR<sub>CG</sub>) 30-69 mL/min.

<sup>d</sup>Osteopenia defined as a T-score of  $-1$  to  $-2.5$ ; osteoporosis defined as a T-score of  $-2.5$  or below.

<sup>e</sup>Estimate for EVG/COBI/FTC/TDF only.



## **eAppendix B. Formulary Scenarios**

To simulate the economic and health-related effects of limiting access to HIV treatments, we developed five formulary scenarios that ranged in their restrictiveness (eAppendix Figure 2). We selected four single-tablet regimens, based on their current market share or innovativeness as a treatment option: emtricitabine/rilpivirine/ tenofovir disoproxil fumarate (FTC/RPV/TDF; brand name: Complera), elvitegravir/cobicistat/ emtricitabine/ tenofovir disoproxil fumarate (EVG/COBI/FTC/TDF; Stribild), elvitegravir/cobicistat/ emtricitabine/ tenofovir alafenamide (EVG/COBI/FTC/TAF; Genvoya), and abacavir/dolutegravir/ lamivudine (ABC/DTG/3TC; Trimeq). In all scenarios, patients who experience virologic failure were allowed to switch to a second-line regimen, darunavir/ritonavir plus 2 or more nucleoside reverse transcriptase inhibitors (NRTIs).

The first scenario, “Open” formulary was designed to be the least restrictive in design. Patients with osteopenia were started on ABC/DTG/3TC or EVG/COBI/FTC/TAF. We used the published literature to estimate that 35.1 percent of patients with HIV had osteopenia not attributable to treatments.<sup>17</sup> Patients with a disposition to a renal event were started on EVG/COBI/FTC/TAF. We estimated that approximately 6.2 percent of HIV patients had renal impairment (eGFR of 30–69 ml/min), based on the published literature.<sup>40</sup> All other patients were started on a TDF-based or TAF-based regimen in proportions such that the overall distribution reflects the current market distribution of patients in the Ryan White program on TAF-based products, 46 percent, as of the second quarter of 2016.<sup>41</sup> Patients moved to an alternative regimen with treatment failure or occurrence of an adverse event. This scenario reflected current market trends among a population facing minimal co-pays and provided the fewest restrictions on access to treatment.

The second scenario, “Pre-Sorted” formulary, was designed to represent a situation in which patients with certain pre-existing tendencies began on therapies better suited to their pre-existing conditions. In this scenario, we stratified patients according to the presence of pre-existing reduced kidney function or low bone mineral density. Patients with no baseline conditions initiated treatment on a TDF-based regimen. In the event of a virologic failure, patients were switched to darunavir/ritonavir plus 2 or more NRTIs. Patients who experienced an adverse event, except renal adverse events, transitioned to ABC/DTG/3TC. In the event of a renal adverse event, patients transitioned to EVG/COBI/FTC/TAF. Patients with renal

impairment initiated on EVG/COBI/FTC/TAF. Patients with reduced kidney function who experienced virologic failure transitioned to darunavir/ritonavir plus 2 or more NRTIs, but patients who experienced an adverse event stayed on EVG/COBI/FTC/TAF. Finally, patients with pre-existing osteopenia initiated treatment on EVG/COBI/FTC/TAF or ABC/DTG/3TC. If these patients experienced virologic failure, they were placed on darunavir/ritonavir plus 2 or more NRTIs. If these patients experienced a renal or fracture adverse event, they transitioned to either ABC/DTG/3TC or EVG/COBI/FTC/TAF—whichever they did not begin on (except that patients experiencing a renal event either remain on or switch to EVG/COBI/FTC/TAF).

Three additional scenarios represented more restrictive formulary designs. In those designs, patients first began on a TDF-based regimen with changes to another therapy allowed if particular events occurred. In the third scenario, “Step Therapy Any AEs”, all patients began on a TDF-based regimen and were transitioned to darunavir/ritonavir plus 2 or more NRTIs in the event of a virologic failure. Patients who discontinued treatment because of the occurrence of any adverse event, however, were transitioned to EVG/COBI/FTC/TAF.

The fourth scenario, “Step Therapy Renal,” was similar to Step Therapy Any AEs in that all patients began on a TDF-based regimen (EVG/COBI/FTC/TDF or FTC/RPV/TDF). Patients who experienced a virologic failure transitioned to darunavir/ritonavir plus 2 or more NRTIs. Similarly, patients who discontinued treatment because of a fracture adverse event transitioned to ABC/DTG/3TC. Patients who experienced a renal adverse event, however, transitioned to EVG/COBI/FTC/TAF.

The final scenario, “Most Restrictive” formulary, was designed to understand the impacts of a restrictive formulary design. In this scenario, all patients were placed on one of two TDF-based regimens (EVG/COBI/FTC/TDF or FTC/RPV/TDF). Patients were allowed to switch to darunavir/ritonavir plus 2 or more NRTIs only in the event of a virologic failure.

We used estimates from clinical trials with differing patient selection criteria to simulate the effects of the different formulary designs. In the Step and Most Restrictive formulary scenarios, the FTC/RPV/TDF and EVG/COBI/FTC/TDF efficacy and failure rates reflected the experience of the general population with HIV. In contrast, in the Pre-Sorted and Open formulary scenarios, patients without osteopenia or renal impairment were given efficacy, failure, and adverse event rates from trials that were restricted to patients without those conditions. Further, in these formularies, efficacy and failure rate estimates for patients with

bone or renal conditions were derived from clinical trials with patient populations that were renally impaired or had low bone mineral density.

#### Treatment Efficacy, Failure and Discontinuation

The treatment efficacy, failure and discontinuation rates were derived from Phase III clinical trials lasting 48 weeks. We used the 48-week period as a proxy for our 52-week model cycle. The efficacy rate was determined by a plasma HIV-1 RNA count of less than 50 copies per ml. The virologic failure rate was determined by the number of patients who had 2 visits of plasma HIV-1 RNA greater than or equal to 50 copies per ml and less than 1 log<sub>10</sub> reduction from baseline at week 8. Finally, we calculated the rate of treatment discontinuation as the number of patients randomized to treatment who discontinued because of death, pregnancy, withdrawal or similar reasons.

As a way to draw distinctions in efficacy and adverse event rates across different formulary scenarios, the model made use of results from clinical trials that differed in terms of inclusion criteria. For example, in the Open and Pre-Sort by Existing Conditions formularies, people with reduced kidney function are placed on EVG/COBI/FTC/TAF at the beginning of treatment, while people without any predisposing conditions for bone or renal problems may be placed on a TDF-based regimen. Hence, at that stage of these formularies, the clinical trial parameters for patients on EVG/COBI/FTC/TAF who have reduced kidney function were taken from a study that was restricted to patients having low kidney function, while the clinical trial parameters for the TDF or TAF patients were based on studies that excluded people with osteopenia or low kidney function.<sup>29,30,35</sup> Alternatively, in the step therapy designs that start all patients on TDF-based regimens, we used parameters from TDF clinical trials that reflected a broader range of patients.<sup>29</sup> Given the above details, we calculated the combined rates of treatment discontinuation and efficacy for each formulary scenario (eAppendix Table 3).

#### Adverse Event Calculations

We selected the occurrence of two adverse events, renal adverse events and bone fractures, as outcomes of interest. We selected these events, as they are often serious in nature and are associated with certain HIV treatment regimens.<sup>42,43</sup> Our outcomes of interest were the number of renal adverse events and bone fractures in each of the formulary scenarios through 2025. To

calculate the number of renal adverse events, we used estimates from Phase III clinical trials on the frequency of renal events over 48 weeks (the trial period). For every model cycle, we applied these rates to the populations treated by each regimen, according to our scenario designs.

We used a similar methodology to calculate the number of bone fractures. Again, we used estimates from Phase III clinical trials on the frequency of bone fractures over 48 weeks (trial period). We then applied these rates every cycle to the populations treated by each regimen, according to the scenario design. The combined rates of adverse events for each formulary scenario are presented in eAppendix Table 3.

**eAppendix Table 3.** Combined Rates of Treatment Efficacy, Discontinuation, and Adverse Events for each Formulary Scenario

Formulary Scenario	Efficacy	Discontinuation	Renal Failure	Bone Fracture
Closed Formulary	85.11%	6.60%	1.46%	3.14%
Step Formulary Renal	85.11%	6.56%	1.46%	3.09%
Step Formulary Any Adverse Event	85.24%	6.47%	1.45%	2.97%
Pre-Sorted Formulary	87.77%	6.00%	0.74%	2.30%
Open Formulary	89.18%	5.51%	0.50%	1.57%

## eAppendix Figure 2. Formulary Scenario Schematics

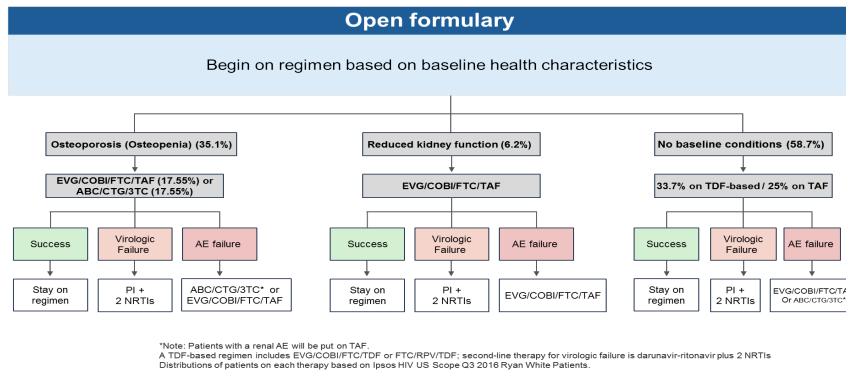
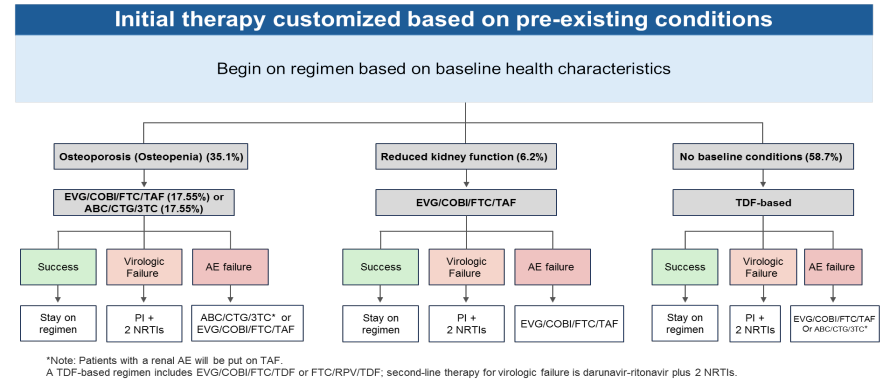
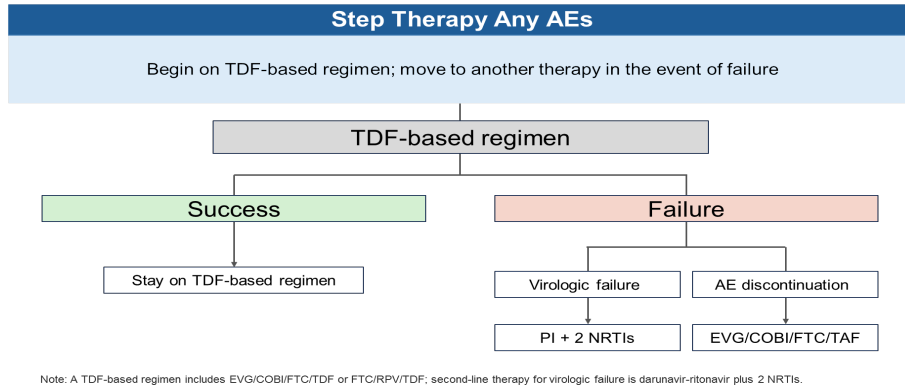
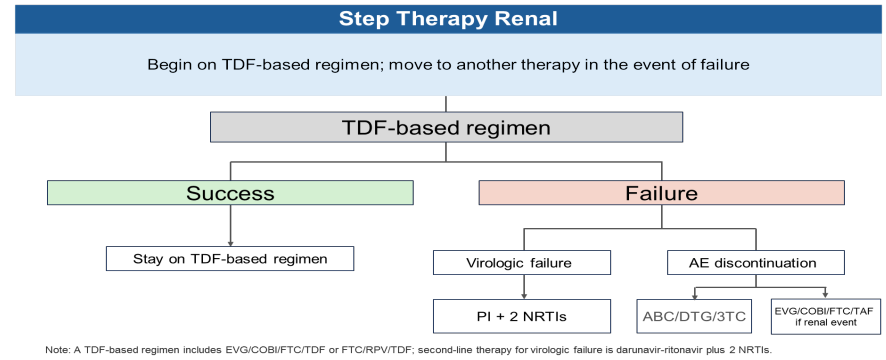
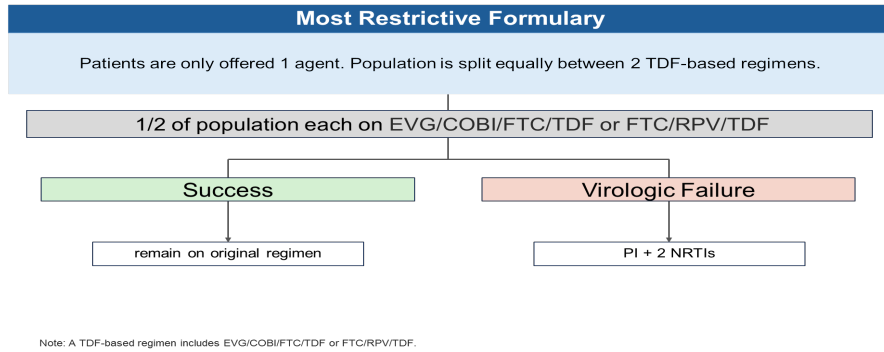

### eAppendix C. Adverse Event Costs

We also selected the medical costs associated with the renal adverse events and bone fractures as other outcomes of interest. To calculate the medical costs of each event, we selected ICD-9 diagnosis codes associated with HIV treatment-related renal adverse event or bone fracture per the published literature (renal adverse event codes: 270, 584, 585; bone fracture codes: 733, 800–829). Using data from the 2014 Medical Expenditure Panel Survey (MEPS), we calculated the mean condition-specific costs associated with the ICD-9 diagnosis codes to derive an estimate for the costs of a renal adverse event and bone fracture (eAppendix Table 4).<sup>44</sup> Finally, we multiplied the cost by the number of each of the events (renal adverse event or bone fracture) over each model cycle. We report cumulative costs from the first ten cycles of the model. All costs were updated to 2016 USD and discounted annually at a rate of 3.0%.

**eAppendix Table 4.** Cost Values Associated with Adverse Events

<b>Component</b>	<b>2016 US dollar value</b>
<i>Bone Fracture</i>	
Inpatient hospital	\$1974
Outpatient hospital	\$470
Emergency room	\$375
Office-based provider	\$794
Prescriptions	\$474
Condition-specific costs	\$4,088
<i>Renal Adverse Event</i>	
Inpatient hospital	\$16,391
Outpatient hospital	\$2479
Emergency room	\$76
Office-based provider	\$11,244
Prescriptions	\$1625
Condition-specific costs	\$31,814

**eAppendix D.** Comparisons of Model Outcomes

**eAppendix Table 5.** Model Comparisons of Patients Treated, Cumulative Deaths and HIV Prevalence

Parameter	Shah et al. <sup>7</sup>	Our model formularies			
		<i>Step Therapy Renal</i>	<i>Step Therapy Any AEs</i>	<i>Pre-Sorted</i>	<i>Open</i>
Percent of HIV patients treated in 2020	50	51.57	50.69	51.36	52.05
Cumulative deaths in 2016–2025	375,000 (364,000–578,000)	532,000	530,000	520,000	515,000
Projected number of prevalent HIV cases in 2025 (million)	1.47 (1.24–1.57)	1.5295	1.5289	1.5273	1.5245



## References

1. Goldman DP, Juday T, Seekins D, Linthicum MT, Romley JA. Early HIV Treatment In The United States Prevented Nearly 13,500 Infections Per Year During 1996–2009. *Health Affairs*. 2014;33(3):362-369.
2. Granich RM, Gilks CF, Dye C, De Cock KM, Williams BG. Universal voluntary HIV testing with immediate antiretroviral therapy as a strategy for elimination of HIV transmission: a mathematical model. *Lancet (London, England)*. 2009;373(9657):48-57.
3. Centers for Disease Control and Prevention. Terms, Definitions, and Calculations Used in CDC HIV Surveillance Publications. 2015; <http://www.cdc.gov/hiv/statistics/surveillance/terms.html>. Accessed July 20, 2016.
4. Hall HI, Holtgrave DR, Tang T, Rhodes P. HIV transmission in the United States: considerations of viral load, risk behavior, and health disparities. *AIDS and Behavior*. 2013;17(5):1632-1636.
5. Skarbinski J, Rosenberg E, Paz-Bailey G, et al. Human immunodeficiency virus transmission at each step of the care continuum in the United States. *JAMA internal medicine*. 2015;175(4):588-596.
6. Centers for Disease Control and Prevention. CDC HIV/AIDS Facts: HIV Transmission Rates in the United States. 2008.
7. Shah M, Perry A, Risher K, et al. Effect of the US National HIV/AIDS Strategy targets for improved HIV care engagement: a modelling study. *The Lancet HIV*. 2016;3(3):e140-e146.
8. Centers for Disease Control and Prevention. Trends in U.S. HIV Diagnoses, 2005-2014.
9. *HIV Surveillance Report, 2016*. Atlanta, GA: CDC; 2016. [cdc.gov/hiv/pdf/library/reports/surveillance/cdc-hiv-surveillance-report-us.pdf](http://cdc.gov/hiv/pdf/library/reports/surveillance/cdc-hiv-surveillance-report-us.pdf). Accessed April 6, 2017.
10. CDC. Monitoring selected national HIV prevention and care objectives by using HIV surveillance data—United States and 6 dependent areas—2015. *HIV AIDS Surveill Suppl Rep*. 2017;22(2). [cdc.gov/hiv/pdf/library/reports/surveillance/cdc-hiv-surveillance-supplemental-report-vol-22-2.pdf](http://cdc.gov/hiv/pdf/library/reports/surveillance/cdc-hiv-surveillance-supplemental-report-vol-22-2.pdf). Accessed April 6, 2017.
11. *Behavioral and Clinical Characteristics of Persons Receiving Medical Care for HIV Infection—Medical Monitoring Project, United States, 2014 Cycle (June 2014- May 2015)*. Atlanta, GA: CDC; 2016. [cdc.gov/hiv/pdf/library/reports/surveillance/cdc-hiv-hssr-mmp-2014.pdf](http://cdc.gov/hiv/pdf/library/reports/surveillance/cdc-hiv-hssr-mmp-2014.pdf). Accessed April 6, 2017.
12. Longini Jr IM, Clark WS, Gardner LI, Brundage JF. The dynamics of CD4+ T-lymphocyte decline in HIV-infected individuals: a Markov modeling approach. *JAIDS Journal of Acquired Immune Deficiency Syndromes*. 1991;4(11):1141-1147.
13. Drabo EF, Hay JW, Vardavas R, Wagner ZR, Sood N. A Cost-effectiveness Analysis of Preexposure Prophylaxis for the Prevention of HIV Among Los Angeles County Men Who Have Sex With Men. *Clin Infect Dis*. 2016;63(11):1495-1504.
14. Compressed Mortality File 2013 (machine readable data file and documentation, CD-ROM Series 20, No. 2T). Hyattsville, Maryland: National Center for Health Statistics; 2015.
15. 2013 National Population Estimates: Monthly Postcensal Resident Population. In: United States Census Bureau, ed.
16. Drabo E, Hay J, Vardavas R, Wagner Z, Sood N. A Cost-Effectiveness Analysis Of Pre-Exposure Prophylaxis (PREP) For The Prevention Of Hiv In The Los Angeles County Msm Population. *Value in Health*. 2014;17(3):A272.

17. Carr A, Grund B, Neuhaus J, et al. Prevalence of and risk factors for low bone mineral density in untreated HIV infection: a substudy of the INSIGHT Strategic Timing of AntiRetroviral Treatment (START) trial. *HIV Med.* 2015;16 Suppl 1:137-146.
18. Estrella MM, Fine DM. Screening for chronic kidney disease in HIV-infected patients. *Advances in chronic kidney disease.* 2010;17(1):26-35.
19. Faruki H, Heine U, Brown T, Koester R, Lai-Goldman M. HLA-B\* 5701 clinical testing: early experience in the United States. *Pharmacogenetics and genomics.* 2007;17(10):857-860.
20. Mallal S, Phillips E, Carosi G, et al. HLA-B\* 5701 screening for hypersensitivity to abacavir. *New England Journal of Medicine.* 2008;358(6):568-579.
21. Small C, Wohl D, Margolis D. Prevalence of HLA-B\* 5701 allele in HIV-infected subjects in North America and reductions in risk for development of abacavir associated hypersensitivity reaction. Paper presented at: 52nd International Conference on Antimicrobial Agents and Chemotherapy (ICAAC)2012.
22. DeJesus E, Rockstroh JK, Henry K, et al. Co-formulated elvitegravir, cobicistat, emtricitabine, and tenofovir disoproxil fumarate versus ritonavir-boosted atazanavir plus co-formulated emtricitabine and tenofovir disoproxil fumarate for initial treatment of HIV-1 infection: a randomised, double-blind, phase 3, non-inferiority trial. *The Lancet.* 2012;379(9835):2429-2438.
23. Sax PE, DeJesus E, Mills A, et al. Co-formulated elvitegravir, cobicistat, emtricitabine, and tenofovir versus co-formulated efavirenz, emtricitabine, and tenofovir for initial treatment of HIV-1 infection: a randomised, double-blind, phase 3 trial, analysis of results after 48 weeks. *Lancet (London, England).* 2012;379(9835):2439-2448.
24. Sax PE, Wohl D, Yin MT, et al. Tenofovir alafenamide versus tenofovir disoproxil fumarate, coformulated with elvitegravir, cobicistat, and emtricitabine, for initial treatment of HIV-1 infection: two randomised, double-blind, phase 3, non-inferiority trials. *The Lancet.* 2015;385(9987):2606-2615.
25. Cohen CJ, Molina J-M, Cahn P, et al. Efficacy and safety of rilpivirine (TMC278) versus efavirenz at 48 weeks in treatment-naive HIV-1-infected patients: pooled results from the phase 3 double-blind randomized ECHO and THRIVE trials. *JAIDS Journal of Acquired Immune Deficiency Syndromes.* 2012;60(1):33-42.
26. Molina JM, Cahn P, Grinsztejn B, et al. Rilpivirine versus efavirenz with tenofovir and emtricitabine in treatment-naive adults infected with HIV-1 (ECHO): a phase 3 randomised double-blind active-controlled trial. *Lancet (London, England).* 2011;378(9787):238-246.
27. Walmsley SL, Antela A, Clumeck N, et al. Dolutegravir plus abacavir-lamivudine for the treatment of HIV-1 infection. *New England Journal of Medicine.* 2013;369(19):1807-1818.
28. Post FA, Winston J, Andrade-Villanueva JF, et al. Elvitegravir/cobicistat/emtricitabine/tenofovir DF in HIV-infected patients with mild-to-moderate renal impairment. *JAIDS Journal of Acquired Immune Deficiency Syndromes.* 2015;68(3):310-313.
29. Pozniak A, Markowitz M, Mills A, et al. Switching to coformulated elvitegravir, cobicistat, emtricitabine, and tenofovir versus continuation of non-nucleoside reverse transcriptase inhibitor with emtricitabine and tenofovir in virologically suppressed adults with HIV (STRATEGY-NNRTI): 48 week results of a randomised, open-label, phase 3b non-inferiority trial. *Lancet Infect Dis.* 2014;14(7):590-599.
30. Mills A, Arribas JR, Andrade-Villanueva J, et al. Switching from tenofovir disoproxil fumarate to tenofovir alafenamide in antiretroviral regimens for virologically suppressed adults

with HIV-1 infection: a randomised, active-controlled, multicentre, open-label, phase 3, non-inferiority study. *Lancet Infect Dis.* 2016;16(1):43-52.

31. Koteff J, Brennan C, Aboud M, et al. Measuring Safety and Satisfaction of ABC/DTG/3TC in a Switch Trial: Secondary Endpoints from the STRIVING Study. Barcelona, Spain October 21-25, 2015 2015.

32. Madruga JV, Berger D, McMurchie M, et al. Efficacy and safety of darunavir-ritonavir compared with that of lopinavir-ritonavir at 48 weeks in treatment-experienced, HIV-infected patients in TITAN: a randomised controlled phase III trial. *The Lancet.* 2007;370(9581):49-58.

33. Clumeck N, Molina JM, Henry K, et al. A randomized, double-blind comparison of single-tablet regimen elvitegravir/cobicistat/emtricitabine/tenofovir DF vs ritonavir-boosted atazanavir plus emtricitabine/tenofovir DF for initial treatment of HIV-1 infection: analysis of week 144 results. *J Acquir Immune Defic Syndr.* 2014;65(3):e121-124.

34. Cohen C, Wohl D, Arribas J, et al. STAR Study: single tablet regimen emtricitabine/rilpivirine/tenofovir DF is non-inferior to efavirenz/emtricitabine/tenofovir DF in ART-naive adults. Paper presented at: Program and abstracts of the 11th International Congress on Drug Therapy in HIV Infection (HIV11)2012.

35. Pozniak A, Arribas J, Gupta S, et al. Safety of tenofovir alafenamide in renal impairment. Paper presented at: HIV Medicine2015.

36. McComsey GA, Kitch D, Daar ES, et al. Bone mineral density and fractures in antiretroviral-naive persons randomized to receive abacavir-lamivudine or tenofovir disoproxil fumarate-emtricitabine along with efavirenz or atazanavir-ritonavir: Aids Clinical Trials Group A5224s, a substudy of ACTG A5202. *The Journal of infectious diseases.* 2011;203(12):1791-1801.

37. Stellbrink HJ, Orkin C, Arribas JR, et al. Comparison of changes in bone density and turnover with abacavir-lamivudine versus tenofovir-emtricitabine in HIV-infected adults: 48-week results from the ASSERT study. *Clin Infect Dis.* 2010;51(8):963-972.

38. Clotet B, Bellos N, Molina JM, et al. Efficacy and safety of darunavir-ritonavir at week 48 in treatment-experienced patients with HIV-1 infection in POWER 1 and 2: a pooled subgroup analysis of data from two randomised trials. *Lancet (London, England).* 2007;369(9568):1169-1178.

39. Healthcare V. A Phase IIIb study of the safety, efficacy, and tolerability of switching to a fixed-dose combination of abacavir/dolutegravir/lamivudine from current antiretroviral regimen. Available from: <https://www.clinicaltrials.gov/ct2/show/NCT02131025>. . Vol NLM identifier: NCT02131025.

40. Estrella MM, Fine DM, Atta MG. Recent developments in HIV-related kidney disease. *HIV therapy.* 2010;4(5):589-603.

41. Ipsos. Percentage of TAF share among Antiretroviral-Naïve Ryan White Patients in Q2 2016. Ipsos HIV US Scope Q2 2016. 2016.

42. Cooper RD, Wiebe N, Smith N, Keiser P, Naicker S, Tonelli M. Systematic review and meta-analysis: renal safety of tenofovir disoproxil fumarate in HIV-infected patients. *Clin Infect Dis.* 2010;51(5):496-505.

43. Harris VW, Brown TT. Bone loss in the HIV-infected patient: evidence, clinical implications, and treatment strategies. *Journal of Infectious Diseases.* 2012;205(suppl 3):S391-S398.

44. Agency for Healthcare Research and Quality. Medical Expenditure Panel Survey: Household Component Event Files. 2014.